

BALLUCCI

CUBBI

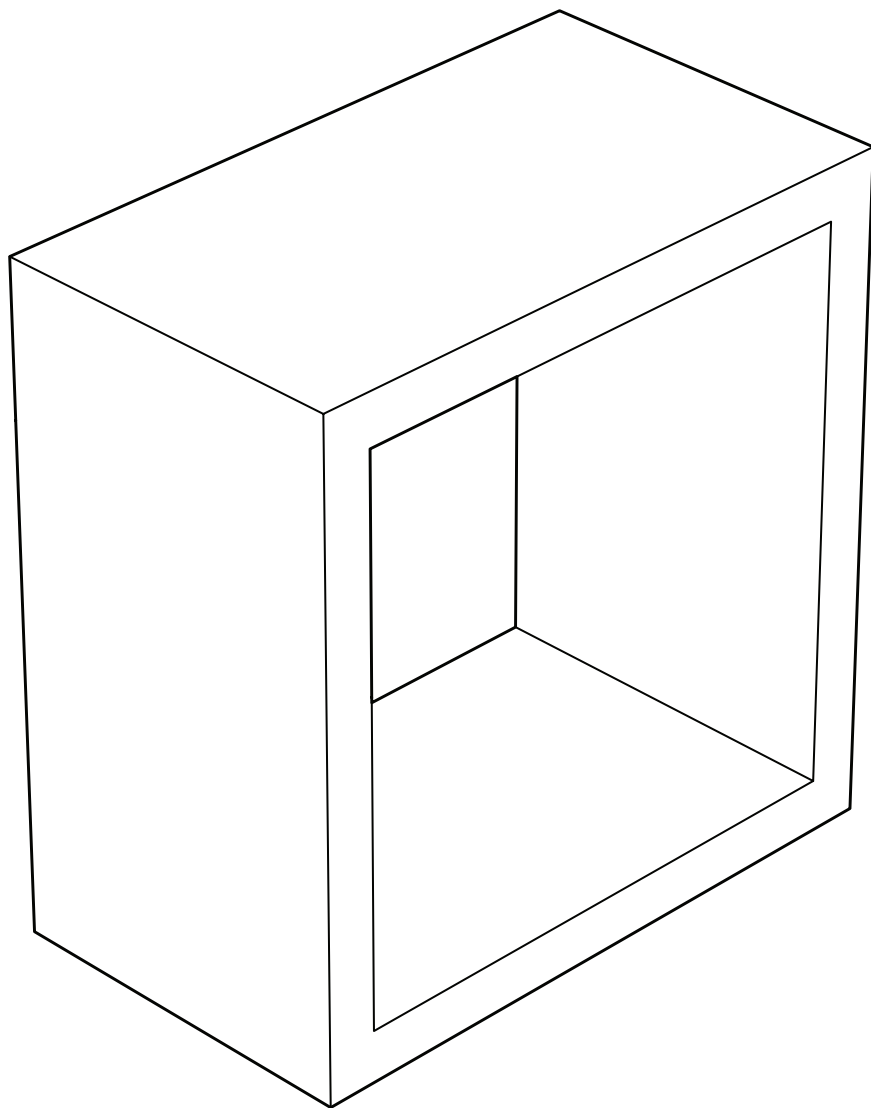

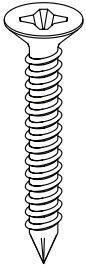

6x

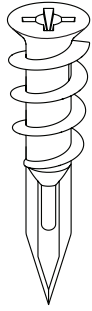

6x

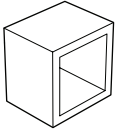

1x

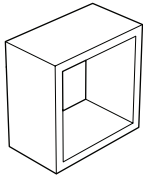

1x

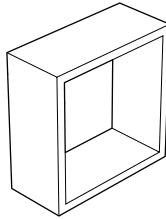

1x

1

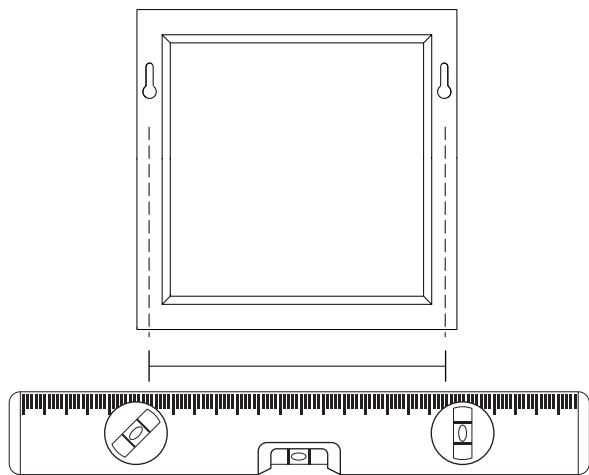

2

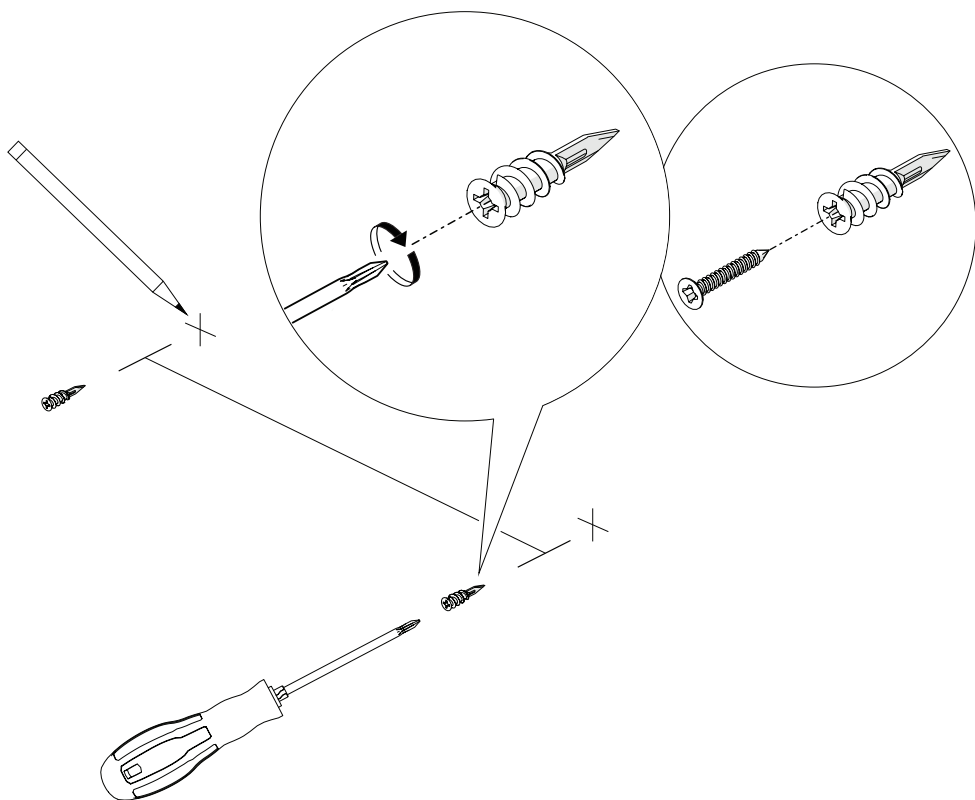

3

